

- ACCESSORI PER DUE COLONNE • ACCESSORIES FOR 2 POST LIFT • ZUBEHÖR FÜR 2-SÄULEN-HEBEBÜHNEN
- ACCESSORIES POUR DEUX COLONNES • ACCESORIOS PARA DOS COLUMNAS

STANDARD ARMS

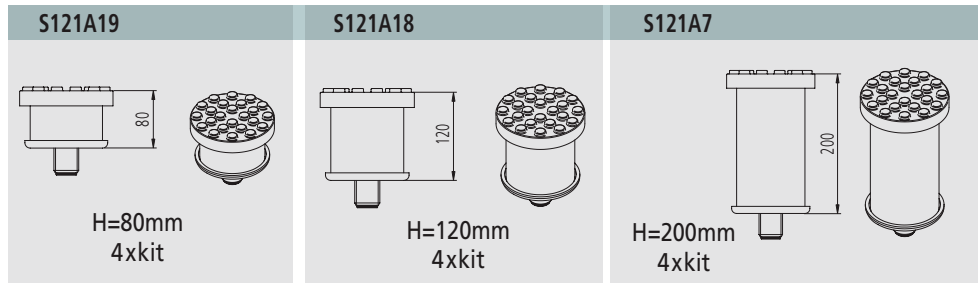

M30 THREAD CAPACITY ≤3200 kg

For Fiat Ducato, Peugeot Boxer, Citroën Jumper
Distanziali / Spacers / Abstandstücke / Rehausses / Espesores

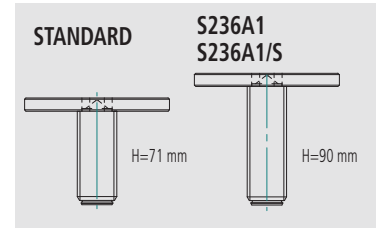

Standard Arms
M30 thread

Special for
Renault Talisman,
Espace

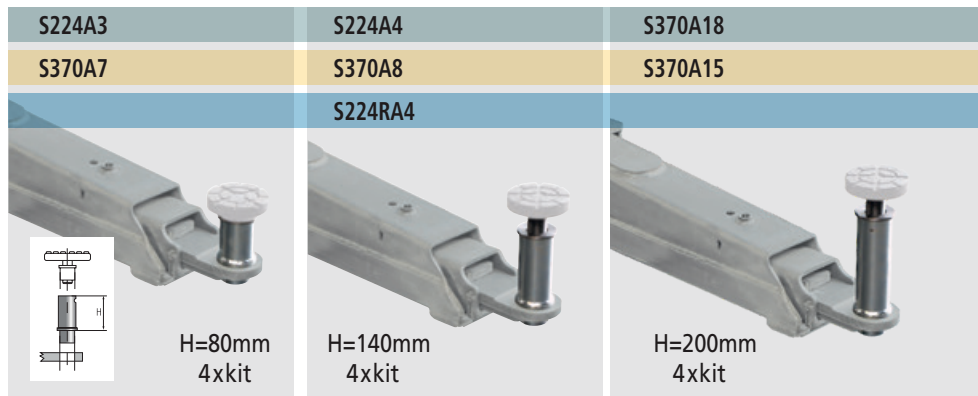

K - LIK - LIKT ARMS Ø 45mm

70LIK ARMS Ø 60mm

R ARMS Ø 55mm

For Fiat Ducato, Peugeot Boxer, Citroën Jumper
Distanziali / Spacers / Abstandstücke / Rehausses / Espesores



QUICK FIT SYSTEM

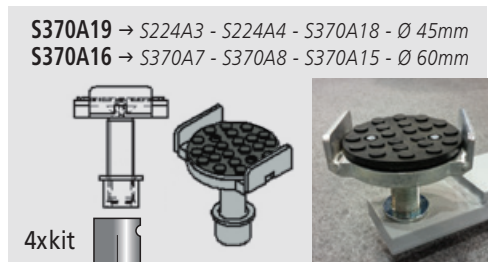

S370A17 → S224A3 - S224A4 - S370A18 - Ø 45mm
S370A14 → S370A7 - S370A8 - S370A15 - Ø 60mm

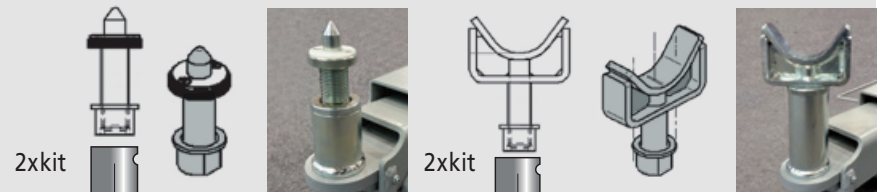

Supporti presa telaio / Frame adapters /
Halterungen für Chassisaufnahme / Supports
prise sur chassis / Espesores de agarre
sobre chasis

For Mercedes Sprinter, VW LT+Crafter
Supporti / Adapters / Halterungen / Supports /
Adaptadores de agarre



Supporti presa telaio / Frame adapters /
Halterungen für Chassisaufnahme / Supports
prise sur chassis / Espesores de agarre
sobre chasis

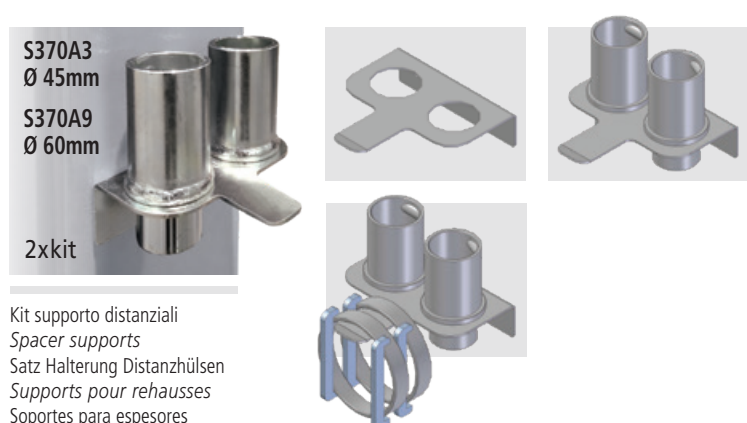

Kit supporto distanziali
Spacer supports
Satz Halterung Distanzhülsen
Supports pour rehausses
Soportes para espesores

MULTI HEIGHT PAD

CAPACITY ≤3500kg

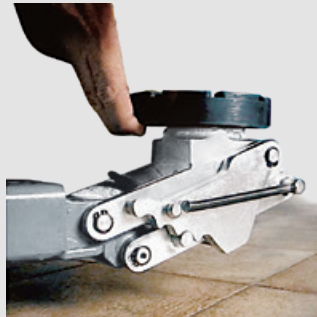
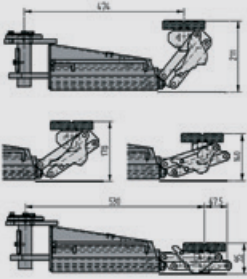

S305A14
S336A1
S234A1

Tampori Estensibili

- 4 altezze (95, 140, 178, 211mm)
- posizionamento rapido
- si alza con due dita e scende tirando il cavalletto
- ulteriore regolazione a vite di 40mm

Flip-up Pads

- 4 heights (95, 140, 178, 211mm)
- quick positioning
- two fingers to push up the pad and lowering by pulling the cable
- further 40mm screw adjustment

Aufklappbare Aufnahmen

- 4 Unterschwenkhöhen (95, 140, 178, 211mm)
- schnell Positionierung
- Heben mit zwei Fingern und senken mit Kabelschnur
- weitere 40mm Erhöhung mit Drehteller

Tampons Extensibles

- 4 hauteurs (95, 140, 178, 211mm)
- positionnement rapide
- levage avec deux doigts et descente en tirant le câble
- réglage ultérieur à vis de 40mm

Tacos Extensibles

- 4 alturas (95, 140, 178, 211mm)
- colocación rápida
- se levanta con dos dedos y se baja tirando el cable
- 40mm más de altura ajustables a rosca

- S305A14/S Fornito installato in fabbrica in sostituzione dei tamponi esistenti
S336A1/S Fitted in factory instead of standard pads
S234A1/S Satz Aufnahmen wie ohne /S Satz bereits werksseitig montiert
S370A2/S Fournis installés en remplacement des tampons existants
S5.337A7X2/S Tacos suministrado ya instalados en lugar de los tacos normales

4x

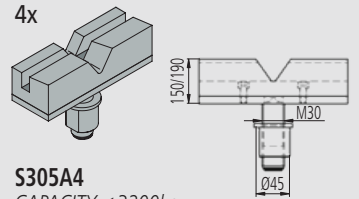

S305A4

CAPACITY ≤3200kg

4x

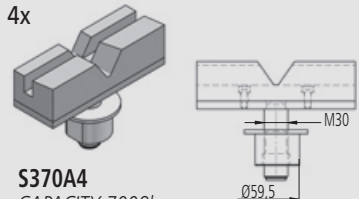

S370A4

CAPACITY 7000kg

For Mercedes 460 range

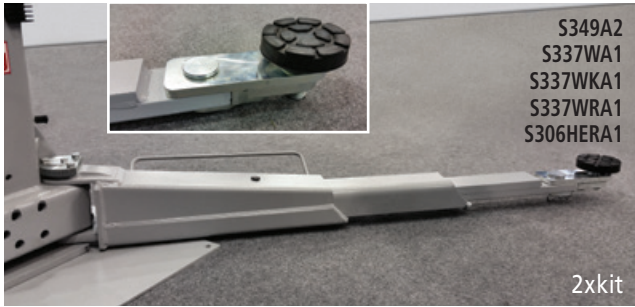

S349A2
S337WA1
S337WKA1
S337WRA1
S306HERA1

2xkit



S370A5
S5.337A9

2xkit

Arm Extension (→For baseless lift, electromechanical synchronization, 4,2 ton capacity, LK arms - lift capacity reduced to 3,5ton)

Set parasportelli / Set of door protections / Satz Türanschläge / Kit protection portes / Juego de protecciones para puertas.

SPECIAL VERSIONS Energy Set

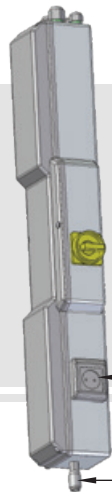

VARxxxxxx / ENERGY
1 PHASE + AIR
Air / Electric utility box

SCHUKO
220V/230V 1 PHASE

UNIVERSAL AIR
CONNECTION M.3/8

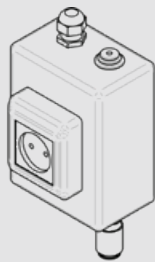

S374A2
1 PHASE + AIR
Air / Electric
utility box

S121A2A



4xkit

Cavalletti per assetto / Alignment stands / Stative für Achsvermessung / Béquilles pour géométrie / Caballetes para alineado

S110A7

Ø 310 mm (12.2")
2x1000 kg (2x2200lbs)

TURNTABLES

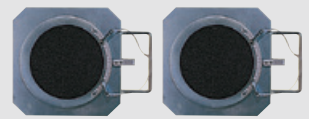

Piatti rotanti / Turntables / Drehplatten / Plateaux pivotants / Platos giratorios

S370A20 (3 PHASE)
S370A21 (1 PHASE)



S370A1T

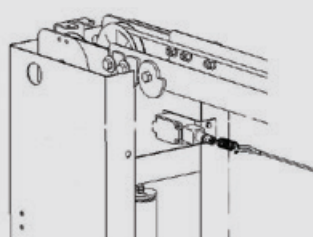

Finecorsa / Limit switch / Endabschalter / Fin de course / Final de carrera

S370A4 (200 mm)
S370A12 (200 mm)

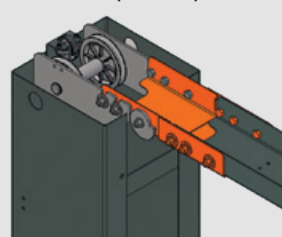

Estensione larghezza / Width extension / Verbreiterung / Extension en largeur / Extensión de anchura

